

Quick Start Guide

DE EN FR IT NL DK

MEISTERSTÜCK

GEN.2

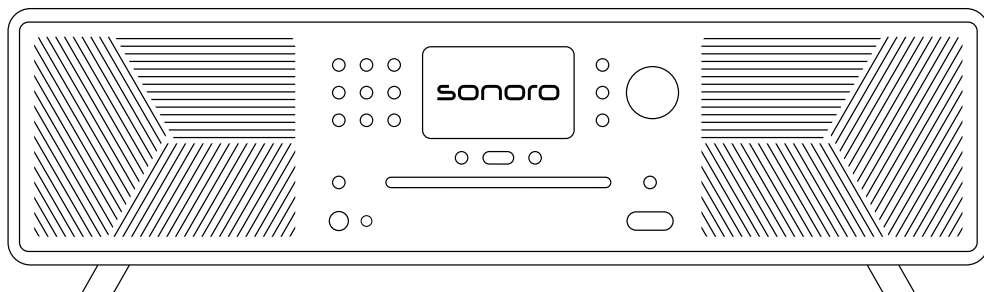

sonoro

GERMAN AUDIO DESIGN
www.sonoro.com

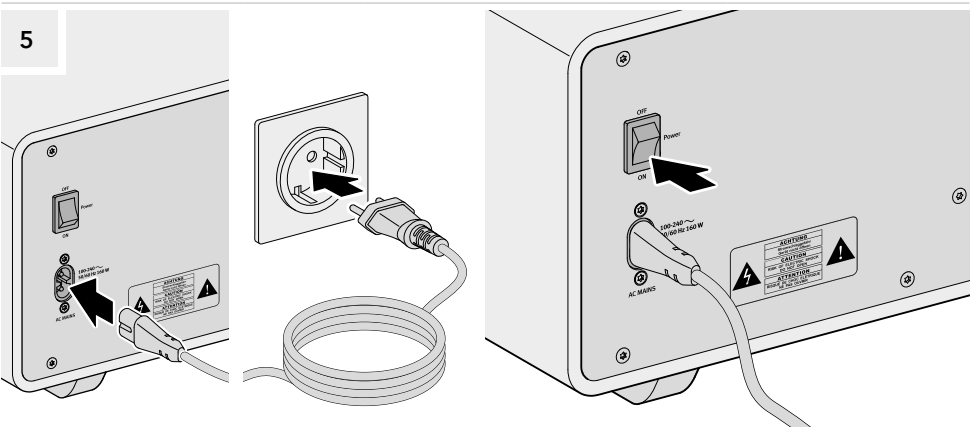
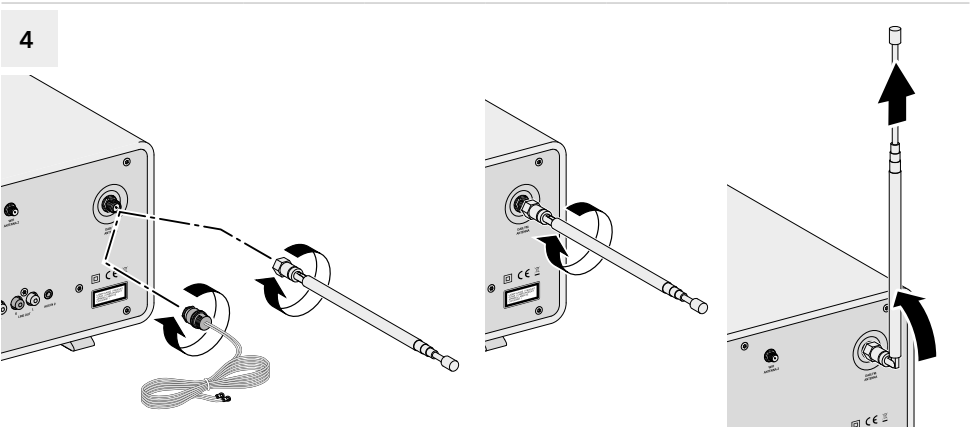
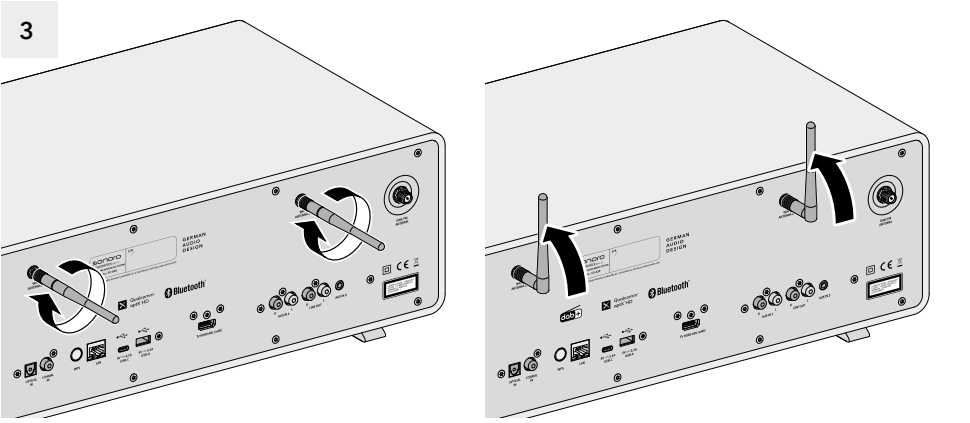
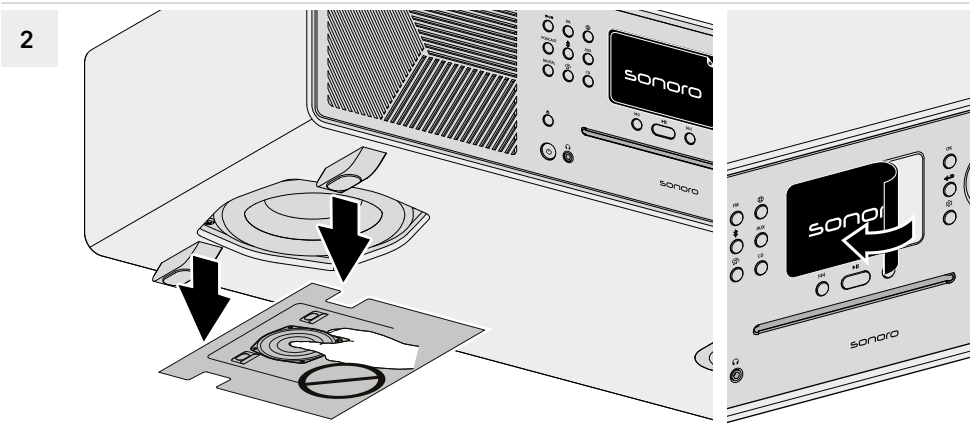
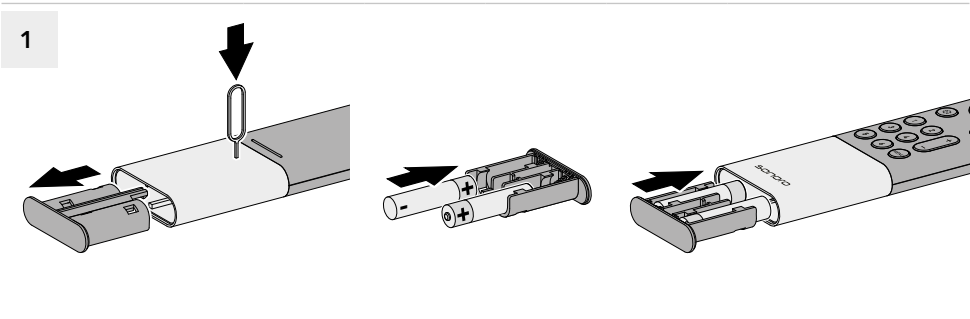
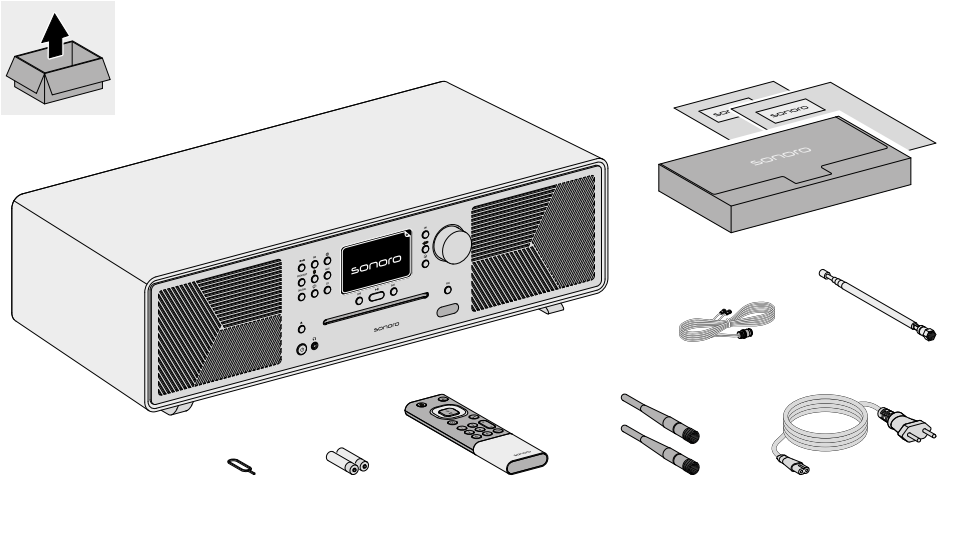

1. Navigation

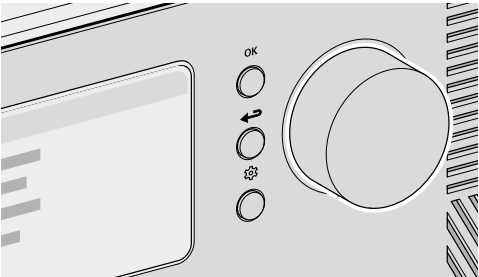

Steuerung und Bedienung des Geräts, um Menüpunkte auszuwählen oder den Anweisungen auf dem Display zu folgen.



Wenn gerade eine Quelle abspielt:
▶ Drehen Sie den Regler, um die Lautstärke zu ändern.

Wenn gerade ein Menü angezeigt wird:
▶ Drehen Sie den Regler, um einen Menüpunkt oder eine Angabe auszuwählen.



Wenn gerade eine Quelle abspielt:
▶ Drücken Sie die Taste, um Informationen zu erhalten (z. B. Titel des laufenden Musikstücks).

Wenn gerade ein Menü angezeigt wird:
▶ Drücken Sie die Taste, um die Auswahl zu bestätigen.



Wenn gerade eine Quelle abspielt:
▶ Drücken Sie die Taste, um das Untermenü der Quelle aufzurufen.

Wenn gerade ein Menü angezeigt wird:
▶ Drücken Sie die Taste, um zurück in das vorherige Menü zu wechseln.



▶ Drücken Sie die Taste, um das Hauptmenü aufzurufen.

2. Ersteinrichtung

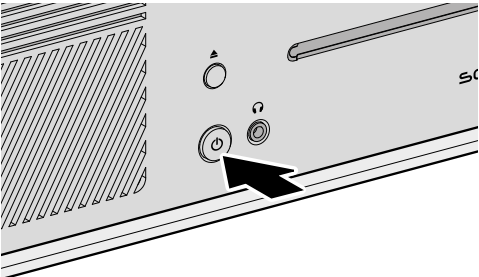

- ▶ Schalten Sie das Gerät ein.
- ▶ Warten Sie ein paar Sekunden.

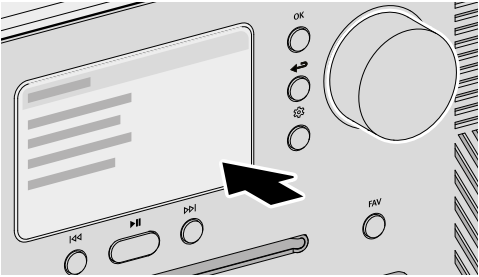

- ▶ Folgen Sie den Anweisungen auf dem Display.
- ▶ Stellen Sie Sprache, Region, Land und Zeitzone ein.

Verbindung zum Netzwerk:
→ Siehe Kapitel „3. Netzwerkverbindung“ (Seite 6).



Weitere Einstellungsmöglichkeiten sind über das Hauptmenü zu erreichen. Folgende Menüs stehen zur Verfügung:

- **Menü** - zur Auswahl der gewünschten Abspielquelle.
- **Klangeinstellungen** - zur Einstellung des Klangs an die eigenen Bedürfnisse (z. B. Höhen, Bass).
- **Sleeptimer** - zur Auswahl und Einstellung der automatischen Abschaltfunktion.
- **Wecker** - zur Einrichtung der Weckfunktion mit eigenen Einstellungen (z. B. Zeit, Abspielquelle, Lautstärke).
- **Zuletzt gehört** - zum Aufrufen der Liste mit den zuletzt gespielten Quellen.
- **Favoriten aufrufen**
→ Siehe Kapitel „5. Favoriten“ (Seite 8).
- **Einstellungen** - zur Auswahl allgemeiner Einstellungsmöglichkeiten des Geräts (z. B. Netzwerk, Sprache, Zeit, Werkseinstellung).



Weitere Informationen zum Gerät und zur Einrichtung (z. B. automatische Anpassung des Klangs an die Raumsituation am Aufstellort) stehen in der Bedienungsanleitung.

<https://manuals.sonoro.com>

3. Netzwerkverbindung

WLAN

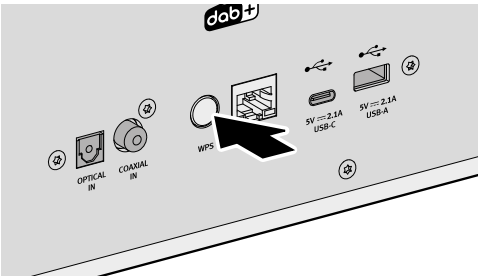

▶ Drücken Sie kurz die WPS-Taste auf der Geräte-Rückseite.

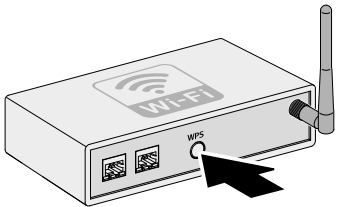

▶ Drücken Sie im Anschluss kurz die WPS-Taste an Ihrem Router.

Die Verbindung wird automatisch hergestellt.

LAN

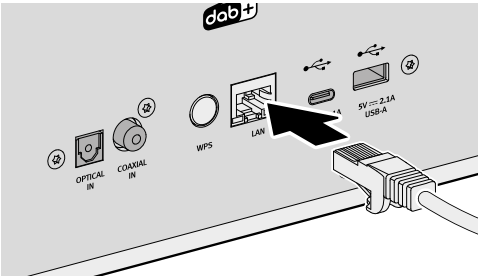

▶ Verbinden Sie das LAN-Kabel mit dem Gerät.

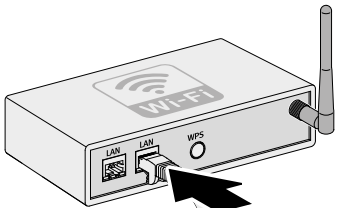

▶ Verbinden Sie das LAN-Kabel mit Ihrem Router.

Die Verbindung wird automatisch hergestellt.

Weitere Verbindungsmöglichkeiten:
Hauptmenü ⇨ Einstellungen ⇨ Netzwerk-Assistent

4. Quellen

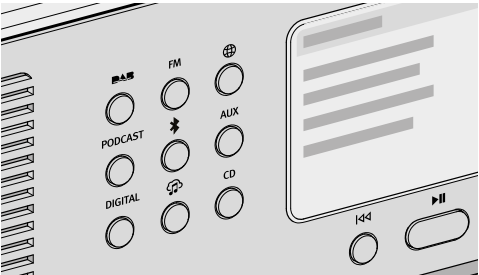

Auswahl der Abspielquelle über eigene Tasten direkt am Gerät.
Die Grundfunktionen (z. B. Wiedergabe, Pause, Wechsel zum nächsten oder vorherigen Titel) stehen für alle Abspielquellen zur Verfügung.

DAB DAB Radio. Zum Abspielen von digitalen Radiosendern, die über Antenne erreichbar sind. Beim ersten Start erfolgt ein automatischer Suchlauf.

FM FM Radio. Zum Abspielen von analogen Radiosendern, die über Antenne erreichbar sind. Beim ersten Start erfolgt ein automatischer Suchlauf.

Internetradio Internetradio. Zum Abspielen von Radiosendern, die per Streaming über das Internet erreichbar sind.

PODCAST Podcast. Zum Abspielen von Podcast-Sendungen, die per Streaming über das Internet erreichbar sind.

Bluetooth® Bluetooth®. Zum Abspielen von gekoppelten Geräten (z. B. Smartphone, Tablet) und zur Wiedergabe auf gekoppelte Geräte (z. B. Kopfhörer, Soundbox).

AUX Zum Abspielen von externen Geräten, die über die Eingänge „AUX 1“ oder „AUX 2“ angeschlossen sind.

DIGITAL Zum Abspielen von externen Geräten, die über die Eingänge „Optical“, „Coaxial“ oder „HDMI“ angeschlossen sind.

Music Note Icon Zum Abspielen von drei Quellen:

- Externe Geräte, die über die Eingänge „USB“ angeschlossen sind.
- Medienserver, die sich im gleichen Netzwerk befinden.
- Streamingdienste, die über das Internet erreichbar sind.
→ Siehe Kapitel „6. sonoro audio App“ (Seite 9).

CD Zum Abspielen von Tonträgern im CD-Laufwerk in den Formaten Audio-CD und MP3/WMA-CD.

Weitere Auswahl von Quellen:
Hauptmenü ⇨ Menu

5. Favoriten

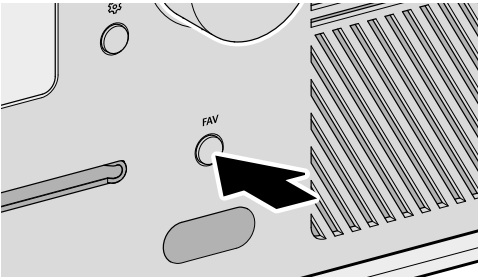

Das Gerät hat eine Speicherkapazität für 99 Favoriten, z. B. für:

- Radiosender
- Podcast-Sendungen
- Titel von Streamingdiensten

Die ersten 6 Speicherplätze in der Favoritenliste sind auch über die Direkttaste auf der Fernbedienung aufrufbar.

Um einen Favoriten zu speichern, muss die gewünschte Quelle gerade abspielen.

FAV ▶ Drücken und halten Sie die Taste, bis die Favoritenliste angezeigt wird.



▶ Wählen Sie einen Speicherplatz.

OK ▶ Drücken Sie die Taste zur Bestätigung.

Um einen Favoriten aufzurufen:

FAV ▶ Drücken Sie kurz die Taste. Die Favoritenliste wird angezeigt.



▶ Wählen Sie den Favoriten.

OK ▶ Drücken Sie die Taste zur Bestätigung.

6. sonoro audio App



Zur Steuerung des Geräts über Smartphone oder Tablet ist die sonoro audio App verfügbar.

Apple App Store (iOS)



Google Play Store (Android)



Musikdienste

Die Verwendung der App bietet weitere Funktionen und Möglichkeiten zur Bedienung. Wenn sich Smartphone oder Tablet über das gleiche WLAN-Netzwerk mit dem Gerät verbinden, ist ein besserer Klang möglich als über die Verbindung per Bluetooth®.



Amazon Music®, Deezer®, Napster® und Qobuz® können nur über die sonoro audio App verbunden werden.



Spotify Connect® und TIDAL Connect® bieten eine direkte Steuerung des Geräts über die App des Streaming-Anbieters.



Externe Geräte, die über die Eingänge „USB“ angeschlossen sind, oder Medienserver, die sich im gleichen Netzwerk befinden, können über die sonoro audio App gesteuert werden.

7. Bedienungsanleitung und Support



Alle Informationen zur Verwendung des Geräts stehen in der Bedienungsanleitung.

<https://manuals.sonoro.com>



Benötigen Sie Hilfe?

▶ Besuchen Sie unsere Support Webseite für mehr Informationen.

<https://support.sonoro.com>

1. Navigation

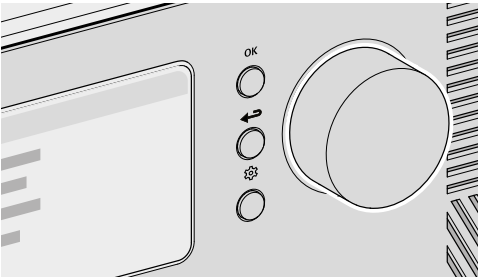

Control and operate the unit to select menu options or follow the instructions on the display.



If a source is currently playing:
▶ Turn the knob to adjust the volume.

If a menu is currently being displayed:
▶ Turn the knob to select a menu item or input.



If a source is currently playing:
▶ Press the button for information (e.g. title of the track currently playing).

If a menu is currently being displayed:
▶ Press the button to confirm the selection.



If a source is currently playing:
▶ Press the button to call up the source submenu.

If a menu is currently being displayed:
▶ Press the button to go back to the previous menu.



▶ Press the button to call up the main menu.

2. Initial setup

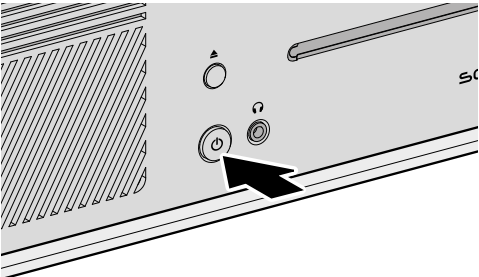

- ▶ Switch on the unit.
- ▶ Wait a few seconds.

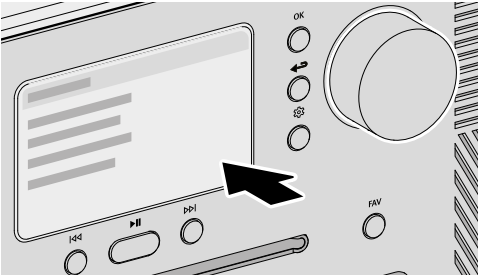

- ▶ Follow the instructions shown on the display.
- ▶ Set the language, region, country and time zone.

Establishing a connection to the network:

→ See chapter "3. Network connection" (page 12).



Further settings are possible via the main menu. The following menus are available:

- **Menu** - for selecting the desired playback source.
- **Sound settings** - for adjusting the sound to personal preferences (e.g. treble, bass).
- **Sleep timer** - for selecting and setting the automatic sleep function.
- **Alarm** - for setting the alarm function with personalised settings (e.g. time, playback source, volume).
- **Recently played** - for calling up a list of your most recent playback sources.
- **Recall from favourites**
→ See chapter "5. Favourites" (page 14).
- **Settings** - for selecting the unit's general settings (e.g. network, language, time, factory settings).



Further information on the unit and setup (e.g. automatic adjustment of the sound to the room in which the unit is installed) can be found in the user manual.

<https://manuals.sonoro.com>

3. Network connection

WLAN

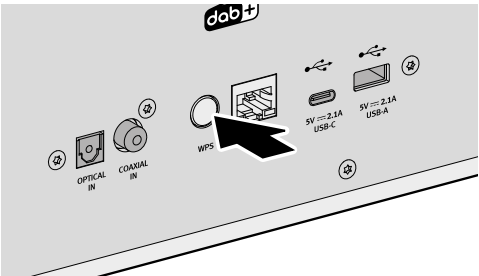

► Briefly press the WPS button on the back of the unit.

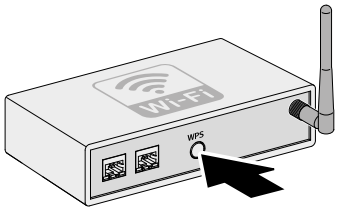

► Then briefly press the WPS button on your router.

The connection will be established automatically.

LAN

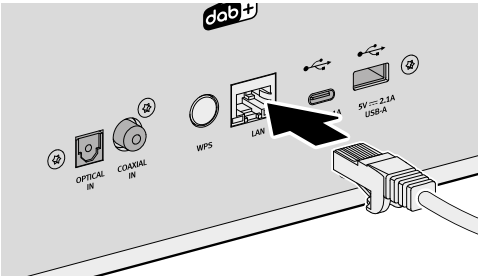

► Connect the LAN cable to the unit.



► Connect the LAN cable to your router.

The connection will be established automatically.

Further connection options:
Main menu → Settings → Network wizard

4. Sources

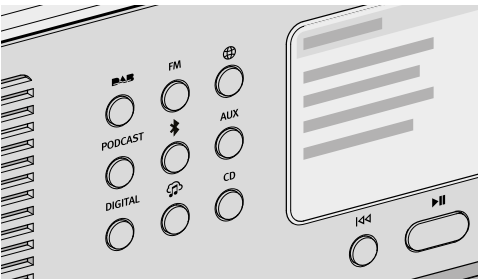

Select the playback source directly via the designated buttons on the unit.
The basic functions (e.g. play, pause, next or previous track) are available for all playback sources.

EN

- DAB** DAB radio. For playback of digital radio stations received via antenna. An automatic search is carried out the first time the unit is started.
- FM** FM radio. For playback of analogue radio stations received via antenna. An automatic search is carried out the first time the unit is started.
- Internet** Internet radio. For playback of radio stations that are streamed via the Internet.
- PODCAST** Podcast. For playback of podcast transmissions that are streamed via the Internet.
- Bluetooth®** Bluetooth®. For playback from paired devices (e.g. smartphone, tablet) and for playback on paired devices (e.g. headphones, soundbox).
- AUX** For playback from external devices that are connected via "AUX 1" or "AUX 2" inputs.
- DIGITAL** For playback from external devices that are connected via "Optical", "Coaxial" or "HDMI" inputs.
- Music icon** For playback from three sources:
 - External devices that are connected via "USB" inputs.
 - Media servers that are on the same network.
 - Streaming services that are available via the Internet.
 - See chapter "6. sonoro audio app" (page 15).
- CD** For playback from sound media in the CD drive in the formats audio CD and MP3/WMA CD.

Further source selection:
Main menu → Menu

5. Favourites

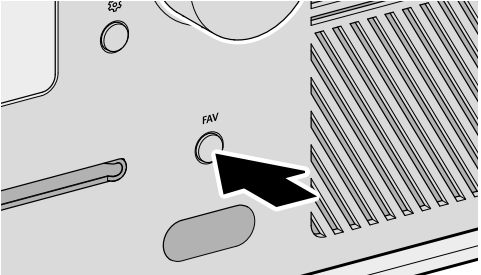

The unit has space to store 99 favourites, e.g. for:

- Radio stations
- Podcast broadcasts
- Streaming service tracks

The first 6 storage spaces in the favourites list can also be called up via the direct button on the remote control.

In order to save a favourite, the desired source must be playing.

FAV ▶ Press and hold the button until the favourites list is displayed.

 ▶ Select a storage space.

OK ▶ Press the button to confirm.

To call up a favourite:

FAV ▶ Briefly press the button. The favourites list is displayed.

 ▶ Select the favourite.

OK ▶ Press the button to confirm.

6. sonoro audio app



The sonoro audio app is available for controlling the unit via smartphone or tablet.

Apple App Store (iOS)



Google Play Store (Android)



EN

Music services

Further functions and options are available when the app is used. Better sound is possible when a smartphone or tablet connects to the unit via the same Wi-Fi network than if connection is established via Bluetooth®.



Amazon Music®, Deezer®, Napster® and Qobuz® can only be connected via the sonoro audio app.



Spotify Connect® and TIDAL Connect® offer direct control of the unit via the streaming provider's app.



External devices connected via the "USB" inputs or media servers located on the same network can be controlled via the sonoro audio app.

7. User manual and support



All information required to operate the unit can be found in the operating manual.

<https://manuals.sonoro.com>



Do you need help?

▶ Visit our support website for more information.

<https://support.sonoro.com>

1. Navigation

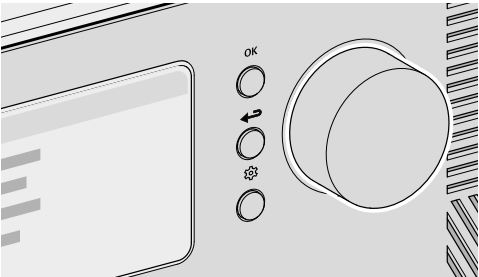

Commande et utilisation de l'appareil pour sélectionner des points de menu ou suivre les instructions sur l'écran.



Si une source est en cours de lecture :
▶ Tournez le bouton de commande pour modifier le volume.

Si un menu est actuellement affiché :
▶ Tournez le bouton de commande pour sélectionner un élément de menu ou une donnée.



Si une source est en cours de lecture :
▶ Appuyez sur la touche pour obtenir des informations (p. ex. le titre du morceau de musique en cours).

Si un menu est actuellement affiché :
▶ Appuyez sur la touche pour confirmer la sélection.



Si une source est en cours de lecture :
▶ Appuyez sur la touche pour accéder au sous-menu de la source.

Si un menu est actuellement affiché :
▶ Appuyez sur la touche pour revenir au menu précédent.



▶ Appuyez sur la touche pour accéder au menu principal.

2. Configuration initiale

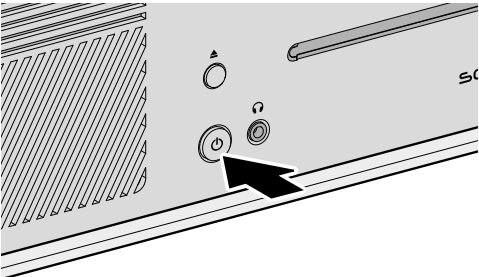

- ▶ Mettez l'appareil en marche.
- ▶ Patientez quelques secondes.

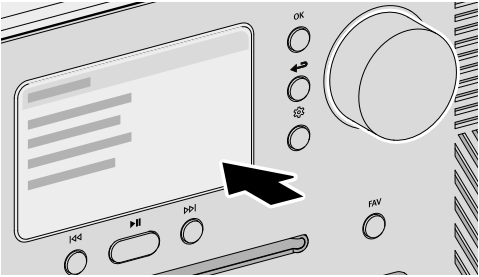

- ▶ Suivez les instructions à l'écran.
- ▶ Réglez la langue, la région, le pays et le fuseau horaire.

Connexion au réseau :
→ Voir le chapitre « 3. Connexion au réseau » (page 18).



D'autres possibilités de réglage sont accessibles via le menu principal. Les menus suivants sont disponibles :

- **Menu** - pour sélectionner la source de lecture.
- **Réglages du son** - pour régler le son en fonction de ses propres besoins (p. ex. aigus, basses).
- **Mode veille** - pour sélectionner et régler la fonction d'arrêt automatique.
- **Alarme** - pour configurer la fonction de réveil avec ses propres réglages (p. ex. heure, source de lecture, volume).
- **Dernières écoutes** - pour afficher la liste des dernières sources lues.
- **Afficher les favoris**
→ Voir le chapitre « 5. Favoris » (page 20).
- **Configuration** - pour sélectionner les possibilités de réglage générales de l'appareil (p. ex. réseau, langue, heure, réglage d'usine).



Le mode d'emploi contient plus d'informations sur l'appareil et la configuration (p. ex. adaptation automatique du son aux conditions ambiantes).

<https://manuals.sonoro.com>

3. Connexion au réseau

WLAN

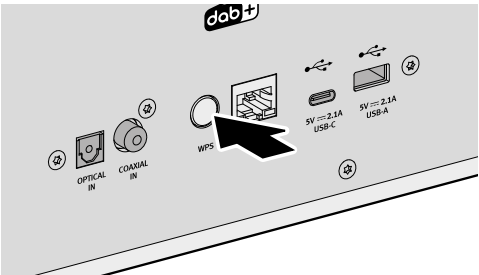

► Appuyez brièvement sur la touche WPS à l'arrière de l'appareil.

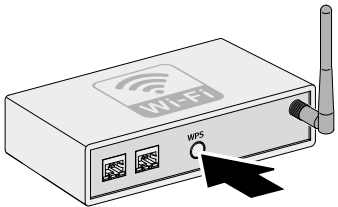

► Appuyez ensuite brièvement sur la touche WPS de votre routeur.

La connexion est établie automatiquement.

LAN

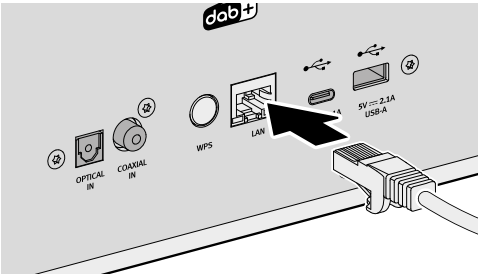

► Connectez le câble LAN à l'appareil.

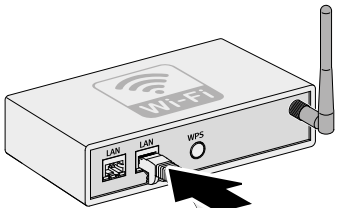

► Connectez le câble LAN à votre routeur.

La connexion est établie automatiquement.

Autres possibilités de connexion :
Menu principal ⇨ Configuration ⇨ Assistant réseau

4. Sources

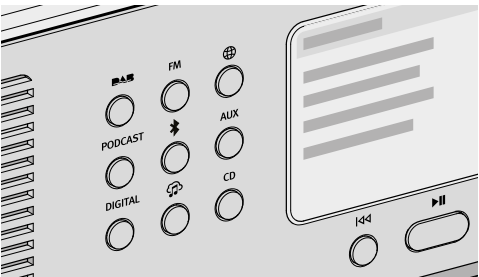

Sélection de la source de lecture via des boutons dédiés directement sur l'appareil.
Les fonctions de base (p. ex. lecture, pause, passage au titre suivant ou précédent) sont disponibles pour toutes les sources de lecture.

FR

- DAB** Radio DAB. Pour écouter les stations de radio numériques accessibles par antenne. Lors du premier démarrage, une recherche automatique est effectuée.
- FM** Radio FM. Pour écouter les stations de radio analogiques accessibles par antenne. Lors du premier démarrage, une recherche automatique est effectuée.
- Internet** Radio Internet. Pour écouter des stations de radio accessibles en streaming via Internet.
- PODCAST** Podcast. Pour écouter des émissions de podcast accessibles en streaming sur Internet.
- Bluetooth®** Bluetooth®. Pour la lecture sur appareils couplés (p. ex. smartphone, tablette) et pour la lecture sur des appareils couplés (p. ex. écouteurs, Soundbox).
- AUX** Pour la lecture sur des appareils externes connectés via les entrées « AUX 1 » ou « AUX 2 ».
- DIGITAL** Pour la lecture sur des appareils externes connectés via les entrées « Optical », « Coaxial » ou « HDMI ».
- MP3** Pour la lecture de trois sources :
 - Périphériques externes connectés via les entrées « USB ».
 - Serveurs de médias qui se trouvent sur le même réseau.
 - Services de streaming accessibles via Internet.
 - Voir le chapitre « 6. Application sonoro audio » (page 21).
- CD** Pour lire des supports sonores dans le lecteur de CD aux formats CD audio et CD MP3/WMA.

Autre sélection de sources :
Menu principal ⇨ Menu

5. Favoris

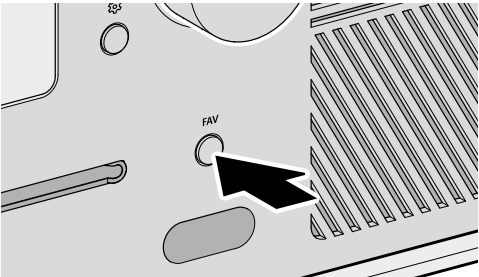

L'appareil a une capacité de mémoire pour 99 favoris, p. ex. pour :

- Stations de radio
- Émissions de podcast
- Titres des services de streaming

Les 6 premiers emplacements de la liste des favoris sont également accessibles via la touche directe de la télécommande.

Pour enregistrer un favori, la source souhaitée doit être en cours de lecture.

FAV ▶ Appuyez sur la touche et maintenez-la enfoncée jusqu'à ce que la liste des favoris s'affiche.



▶ Choisissez un emplacement de stockage.

OK ▶ Appuyez sur la touche pour confirmer.

Pour afficher un favori :

FAV ▶ Appuyez brièvement sur la touche. La liste de favoris s'affiche.



▶ Sélectionnez le favori.

OK ▶ Appuyez sur la touche pour confirmer.

6. Application sonore audio

 L'application sonore audio est disponible pour contrôler l'appareil via un smartphone ou une tablette.

Apple App Store (iOS)



Google Play Store (Android)



FR

Services musicaux

L'utilisation de l'application offre d'autres fonctions et possibilités d'utilisation. Si le smartphone ou la tablette se connecte à l'appareil via le même réseau WLAN, il est possible d'obtenir un meilleur son qu'avec la connexion Bluetooth®.



Amazon Music®, Deezer®, Napster® et Qobuz® ne peuvent être connectés que via l'application sonore audio.



Spotify Connect® et TIDAL Connect® offrent un contrôle direct de l'appareil via l'application du fournisseur de streaming.



Les appareils externes connectés via les entrées « USB » ou les serveurs média qui se trouvent sur le même réseau peuvent être contrôlés via l'application sonore audio.

7. Mode d'emploi et support



Le mode d'emploi contient toutes les informations relatives à l'utilisation de l'appareil.

<https://manuals.sonoro.com>



Besoin d'aide ?

▶ Consultez notre site d'assistance pour plus d'informations.

<https://support.sonoro.com>

1. Navigazione

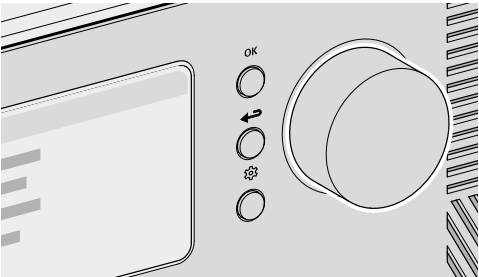

Controllo e funzionamento del dispositivo per selezionare le voci di menu o seguire le istruzioni visualizzate sul display.



Quando è in corso la riproduzione di una sorgente:
▶ Ruotare la manopola per modificare il volume.

Quando viene visualizzato un menu:
▶ Ruotare la manopola di controllo per selezionare un elemento o una voce di menu.



Quando è in corso la riproduzione di una sorgente:
▶ Premere il tasto per ottenere informazioni (ad es. il titolo del brano musicale riprodotto).

Quando viene visualizzato un menu:
▶ Premere il tasto per confermare la selezione.



Quando è in corso la riproduzione di una sorgente:
▶ Premere il tasto per accedere al sottomenu della sorgente.

Quando viene visualizzato un menu:
▶ Premere il tasto per tornare al menu precedente.



▶ Premere il tasto per accedere al menu principale.

2. Impostazione iniziale

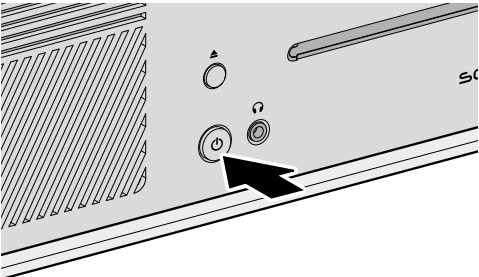

- ▶ Accendere il dispositivo.
- ▶ Attendere qualche secondo.

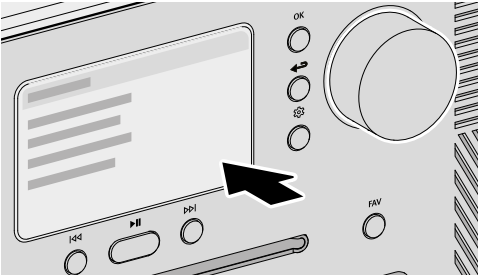

- ▶ Seguire le istruzioni visualizzate sul display.
- ▶ Impostare la lingua, la regione, il paese e il fuso orario.

Connessione alla rete:
→ Vedi capitolo "3. Connessione di rete" (pagina 24).



Ulteriori opzioni di impostazione sono accessibili tramite il menu principale. Sono disponibili i seguenti menu:

- **Menu** - per selezionare la sorgente di riproduzione desiderata.
- **Impostazioni audio** - per regolare il suono in base alle proprie esigenze (ad es. acuti, bassi).
- **Sleep timer** - per selezionare e impostare la funzione di spegnimento automatico.
- **Sveglia** - per impostare la funzione sveglia con le proprie impostazioni (ad es. ora, sorgente di riproduzione, volume).
- **Ultimo ascolto** - per richiamare l'elenco con le sorgenti riprodotte di recente.
- **Richiamare i preferiti**
→ Vedi capitolo "5. Preferiti" (pagina 26).
- **Impostazioni** - per selezionare le opzioni di impostazione generali del dispositivo (ad es. rete, lingua, ora, impostazioni di fabbrica).



Per ulteriori informazioni sul dispositivo e sulla configurazione (ad es. regolazione automatica del suono in base alla situazione ambientale nel luogo di installazione), consultare le istruzioni per l'uso.

<https://manuals.sonoro.com>

3. Connessione di rete

WLAN

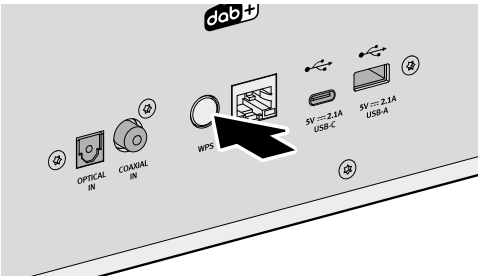

► Premere brevemente il tasto WPS sul retro del dispositivo.

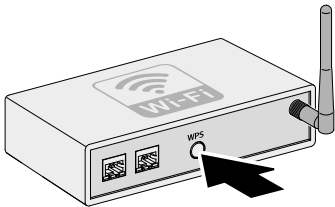

► Premere poi brevemente il tasto WPS sul router.

La connessione viene stabilita automaticamente.

LAN

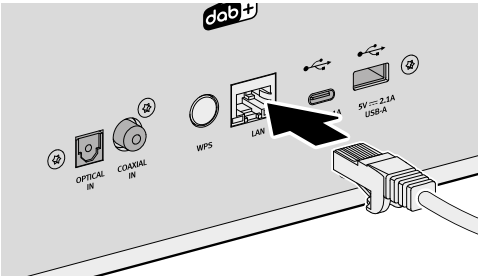

► Collegare il cavo LAN al dispositivo.

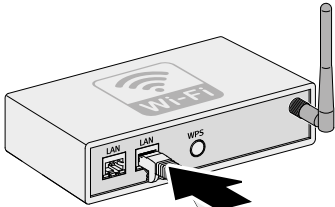

► Collegare il cavo LAN al router.

La connessione viene stabilita automaticamente.

Ulteriori opzioni di connessione:
Menu principale ⇨ Impostazioni ⇨ Assistente di rete

4. Sorgenti

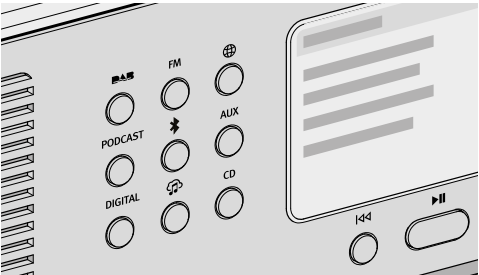

Selezione della sorgente di riproduzione tramite tasti dedicati direttamente sul dispositivo.

Le funzioni di base (ad es. riproduzione, pausa, passaggio alla traccia successiva o precedente) sono disponibili per tutte le sorgenti di riproduzione.

IT

- DAB** Radio DAB. Per la riproduzione di stazioni radio digitali raggiungibili tramite antenna. La ricerca automatica viene eseguita al primo avvio del dispositivo.
- FM** Radio FM. Per la riproduzione di stazioni radio analogiche raggiungibili tramite antenna. La ricerca automatica viene eseguita al primo avvio del dispositivo.
- Internet** Radio via Internet. Per la riproduzione di stazioni radio accessibili in streaming tramite Internet.
- PODCAST** Podcast. Per la riproduzione di programmi podcast accessibili in streaming tramite Internet.
- Bluetooth** Bluetooth®. Per la riproduzione da dispositivi accoppiati (ad es. smartphone, tablet) e la riproduzione su dispositivi accoppiati (ad es. cuffie, soundbox).
- AUX** Per la riproduzione di dispositivi esterni collegati tramite gli ingressi "AUX 1" o "AUX 2".
- DIGITAL** Per la riproduzione di dispositivi esterni collegati tramite gli ingressi "Optical", "Coaxial" o "HDMI".
- Music Note** Per la riproduzione di tre sorgenti:
 - Dispositivi esterni collegati tramite gli ingressi "USB".
 - Server multimediali presenti nella stessa rete.
 - Servizi di streaming accessibili in streaming tramite Internet.
→ Vedi capitolo "6. App sonoro audio" (pagina 27).
- CD** Per la riproduzione di supporti audio con l'unità CD nei formati CD audio e CD MP3/WMA.

Ulteriore selezione delle sorgenti:
Menu principale ⇨ Menu

5. Preferiti

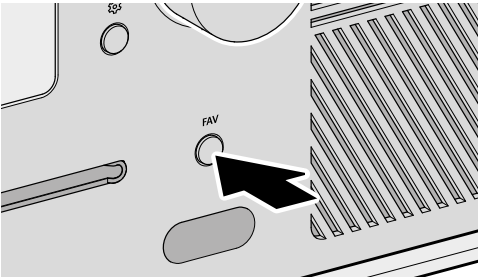

Il dispositivo possiede una capacità di memoria per 99 preferiti, ad es. per:

- Stazioni radio
- Trasmissioni podcast
- Titoli da servizi di streaming

Le prime 6 posizioni di memorizzazione dell'elenco dei preferiti possono essere richiamate anche tramite il tasto diretto del telecomando.

Per salvare un preferito, la sorgente desiderata deve essere in riproduzione.

FAV ▶ Tenere premuto il tasto fino a quando non viene visualizzato l'elenco dei preferiti.



▶ Selezionare una posizione di memoria.

OK ▶ Premere il tasto per confermare.

Per richiamare un preferito:

FAV ▶ Premere brevemente il tasto. Viene visualizzato l'elenco dei preferiti.



▶ Selezionare il preferito.

OK ▶ Premere il tasto per confermare.

6. App sonora audio

Per controllare il dispositivo tramite smartphone o tablet è disponibile l'app sonora audio.



Apple App Store (iOS)



Google Play Store (Android)



IT

Servizi musicali

L'utilizzo dell'app offre ulteriori funzioni e possibilità di utilizzo. Se uno smartphone o un tablet si collega al dispositivo tramite la stessa rete Wi-Fi, è possibile ottenere un suono migliore rispetto alla connessione Bluetooth®.



Amazon Music®, Deezer®, Napster® e Qobuz® possono essere collegati solo tramite l'app sonora audio.

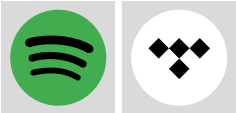

Spotify Connect® e TIDAL Connect® offrono il controllo diretto dell'unità tramite l'app del provider di streaming.



I dispositivi esterni collegati tramite gli ingressi "USB" o i media server presenti nella stessa rete possono essere controllati tramite l'app sonora audio.

7. Istruzioni per l'uso e supporto



Tutte le informazioni sull'uso dell'apparecchio sono contenute nelle istruzioni per l'uso.

<https://manuals.sonoro.com>



Hai bisogno di aiuto?

▶ Per ulteriori informazioni, visita il nostro sito web di supporto.

<https://support.sonoro.com>

1. Navigatie

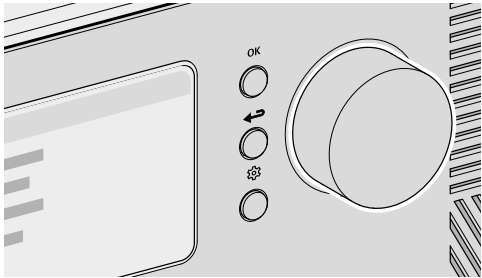

Besturing en bediening van het apparaat om menu-items te selecteren of instructies op het display te volgen.



Als er al een bron wordt afgespeeld:

- ▶ Draai aan de knop om het geluidsvolume aan te passen.

Als er al een menu wordt weergegeven:

- ▶ Draai aan de knop om een keuze te maken uit het menu.



Als er al een bron wordt afgespeeld:

- ▶ Druk op de knop voor meer informatie (bijv. de titel van het nummer dat wordt afgespeeld).

Als er al een menu wordt weergegeven:

- ▶ Druk op de knop om de keuze te bevestigen.



Als er al een bron wordt afgespeeld:

- ▶ Druk op de knop om naar het submenu van de bron te gaan.

Als er al een menu wordt weergegeven:

- ▶ Druk op de knop om terug te gaan naar het vorige menu.



- ▶ Druk op de knop om naar het hoofdmenu te gaan.

2. Installatie

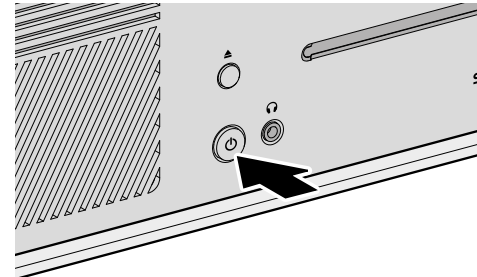

- ▶ Zet het apparaat aan.
- ▶ Wacht enkele seconden.

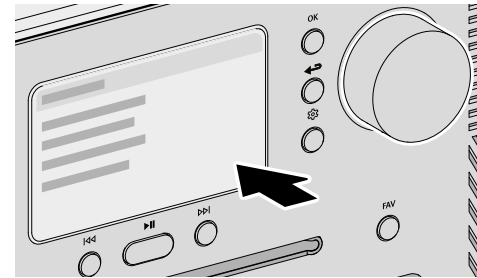

- ▶ Volg de aanwijzingen op het display.
- ▶ Stel taal, regio, land en tijdzone in.

Verbinding met netwerk:

- Zie hoofdstuk "3. Netwerkverbinding" (pagina 30).



Meer mogelijkheden voor instellingen zijn er via het hoofdmenu.

De volgende menu's zijn beschikbaar:

- **Menu** - om de gewenste bron te kiezen.
- **Geluidsafstelling** - om het geluid naar eigen smaak aan te passen (bijv. hoge tonen, bas).
- **Sleeptimer** - voor het kiezen en instellen van automatisch uitschakelen.
- **Wekker** - voor de mogelijkheden van de wekfunctie met eigen instellingen (bijv. tijd, afspelerbron en geluidsvolume).
- **Laatst beluisterd** - voor de lijst met recent afgespeelde bronnen.
- **Favorieten oproepen**
 - Zie hoofdstuk "5. Favorieten" (pagina 32).
- **Instellingen** - voor het kiezen van algemene apparaatinstellingen (bijv. netwerk, taal, tijd en fabrieksinstellingen).



Meer informatie over het apparaat en mogelijkheden (bijv. automatische aanpassing van het geluid aan de ruimte waar het apparaat zich bevindt) is te vinden in de handleiding.

<https://manuals.sonoro.com>

3. Netwerkverbinding

WLAN

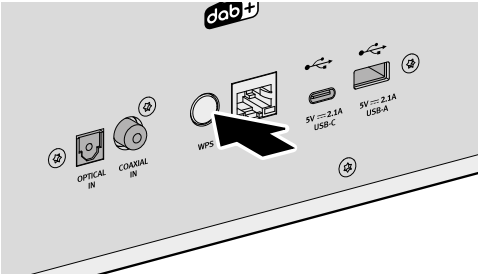

► Druk kort op de WPS-knop aan de achterkant van het apparaat.

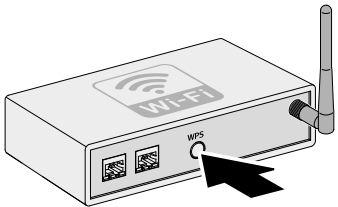

► Druk dan kort op de WPS-knop op de router.

De verbinding wordt automatisch tot stand gebracht.

LAN

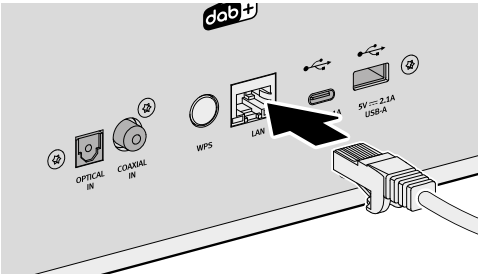

► Sluit eerst de LAN-kabel op het apparaat aan.



► Sluit de LAN-kabel dan aan op de router.

De verbinding wordt automatisch tot stand gebracht.

Andere verbindingen:
Hoofdmenu ⇨ Instellingen ⇨ Netwerkasistent

4. Bronnen

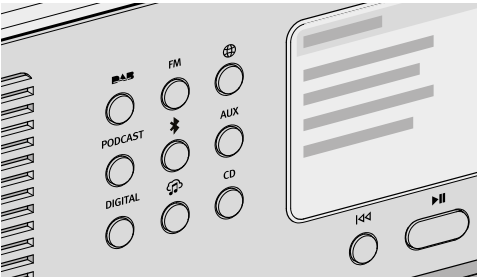

Keuze van afspelenbronnen via de eigen knoppen rechtstreeks op het apparaat. De basisfuncties (bijv. afspelen, pauzeren, naar de vorige of volgende titel) zijn beschikbaar voor alle afspelenbronnen.

- DAB** DAB-radio. Voor het afspelen van digitale radiozenders die via de antenne te ontvangen zijn. Bij de eerste start wordt meteen automatisch naar beschikbare zenders gezocht.
- FM** FM-radio. Voor het afspelen van analoge radiozenders die via de antenne te ontvangen zijn. Bij de eerste start wordt meteen automatisch naar beschikbare zenders gezocht.
- Internetradio** Internetradio. Voor het afspelen van radiozenders die via internet te streamen zijn.
- PODCAST** Podcast. Voor het afspelen van podcastuitzendingen die via internet te streamen zijn.
- Bluetooth®** Bluetooth®. Voor het afspelen van gekoppelde apparaten (bijv. smartphone en tablet) en voor weergave via gekoppelde apparaten (bijv. koptelefoon of soundbox).
- AUX** Voor het afspelen van externe apparaten via de ingangen AUX 1 of AUX 2.
- DIGITAL** Voor het afspelen van externe apparaten via de optische, coax- of HDMI-ingang.
- Music Note Icon** Voor het afspelen van drie bronnen:
 - Externe apparaten via USB-aansluiting.
 - Mediaservers binnen het eigen netwerk.
 - Streamingdiensten via internet.
 - Zie hoofdstuk "6. Audio-app van sonora" (pagina 33).
- CD** Voor het afspelen in het cd-station van geluidsdragers met audio en met mp3/wma-bestanden.

Verdere selectie van bronnen:
Hoofdmenu ⇨ Menu

5. Favorieten

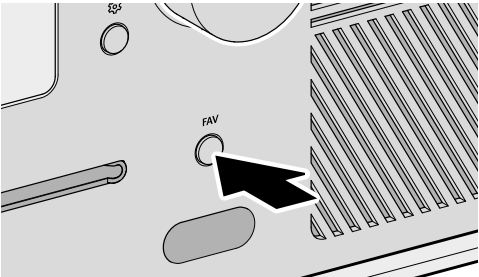

Het apparaat heeft een opslagcapaciteit voor 99 favorieten, bijv. voor:

- Radiozenders
- Podcastuitzendingen
- Titels van streamingdiensten

De eerste 6 plaatsen in de favorietenlijst kunnen ook direct via de knoppen op de afstandsbediening worden geselecteerd.

Om een favoriet op te kunnen slaan, moet de gewenste bron op dat moment worden afgespeeld.

FAV ▶ Druk op de toets tot de favorietenlijst verschijnt.



▶ Kies een plaats om op te slaan.

OK ▶ Druk op de knop om te bevestigen.

Voor het selecteren van een favoriet:

FAV ▶ Druk kort op de knop. De favorietenlijst verschijnt.



▶ Kies de favoriet.

OK ▶ Druk op de knop om te bevestigen.

6. Audio-app van sonoro



Voor het aansturen van het apparaat via smartphone of tablet is de speciale audio-app van sonoro beschikbaar.

Apple App Store (iOS)



Google Play Store (Android)



Muziekdiensten

Het gebruik van de app biedt toegang tot extra functies en mogelijkheden voor bediening. Smartphones en tablets in hetzelfde WLAN-netwerk bieden in verbinding met het apparaat een betere geluidskwaliteit dan verbinding via Bluetooth®.



Amazon Music®, Deezer®, Napster® en Qobuz® kunnen alleen worden verbonden via de sonoro audio app.



Met Spotify Connect® en TIDAL Connect® kan het apparaat rechtstreeks worden bediend via de apps van de betreffende streamingdienst.



Externe apparaten via USB-aansluiting en mediaservers binnen het eigen netwerk kunnen via de audio-app van sonoro worden bediend.

7. Handleiding en ondersteuning



Alle informatie voor het gebruik van het apparaat is te vinden in de handleiding.

<https://manuals.sonoro.com>



Hulp nodig?

▶ Ga voor ondersteuning naar onze website.

<https://support.sonoro.com>

1. Navigation

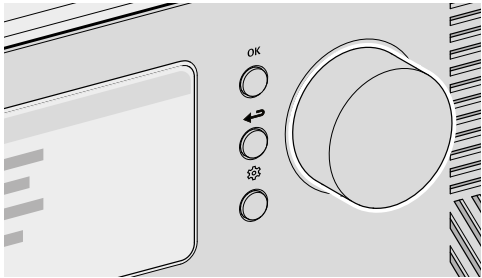

Kontrol og betjening af enheden for at vælge menupunkter eller følge instruktionerne på displayet.



Under afspilning af en kilde:

- ▶ Drej på knappen for at ændre lydstyrken.

Under visning af en menu:

- ▶ Drej på knappen for at vælge et menupunkt eller en angivelse.



Under afspilning af en kilde:

- ▶ Tryk på knappen for at få oplysninger (f.eks. titlen på det aktuelle nummer).

Under visning af en menu:

- ▶ Tryk på knappen for at bekræfte valget.



Under afspilning af en kilde:

- ▶ Tryk på knappen for at åbne kildens undermenu.

Under visning af en menu:

- ▶ Tryk på knappen for at gå tilbage til den foregående menu.



- ▶ Tryk på knappen for at åbne hovedmenuen.

2. Første opsætning

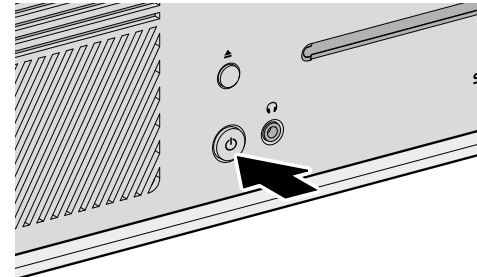

- ▶ Tænd enheden.
- ▶ Vent et par sekunder.

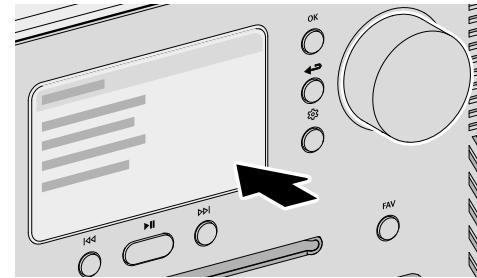

- ▶ Følg anvisningerne på displayet.
- ▶ Indstil sprog, område, land og tidszone.

Forbindelse til netværket:

- Se kapitel "3. Netværksforbindelse" (side 36).

DK



Du finder flere indstillingsmuligheder via hovedmenuen. Følgende menuer er til rådighed:

- **Menu** - til valg af den ønskede afspilningskilde.
- **Lydindstillinger** - til indstilling af lyden efter dine egne behov (f.eks. diskant, bas).
- **Sleeptimer** - til valg og indstilling af den automatiske slukfunktion.
- **Vækkeur** - til indstilling af vækkefunktionen med egne indstillinger (f.eks. tid, afspilningskilde, lydstyrke).
- **Hørt senest** - til åbning af listen med de senest afspillede kilder.
- **Åbning af favoritter**
 - Se kapitel "5. Favoritter" (side 38).
- **Indstillinger** - til valg af enhedens generelle indstillingsmuligheder (f.eks. netværk, sprog, tid, fabriksindstilling).



Du finder flere oplysninger vedrørende enheden og indstillinger (f.eks. automatisk tilpasning af lyden til rumforholdene på opstillingsstedet) i betjeningsvejledningen.

<https://manuals.sonoro.com>

3. Netværksforbindelse

WLAN

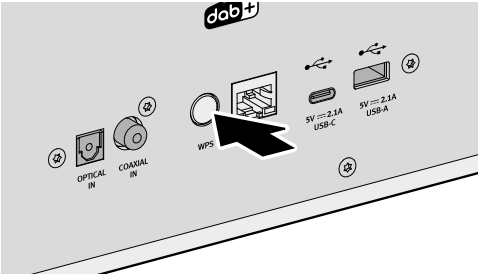

▶ Tryk kortvarigt på WPS-knappen på bagsiden af enheden.



▶ Tryk derefter kortvarigt på WPS-knappen på routeren.

Forbindelsen oprettes automatisk.

LAN

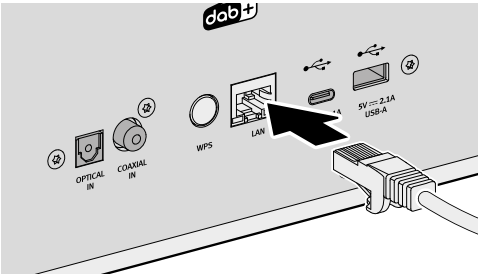

▶ Forbind LAN-kablet med enheden.

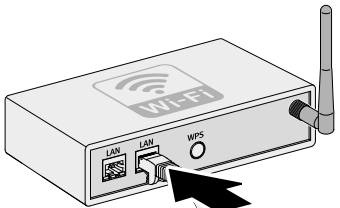

▶ Forbind LAN-kablet med routeren.

Forbindelsen oprettes automatisk.

Flere forbindelsesmuligheder:
Hovedmenu ⇨ Indstillinger ⇨ Netværksassistent

4. Kilder

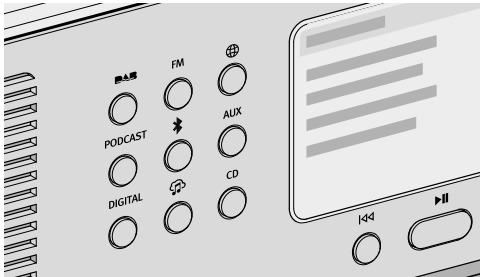

Valg af afspilningskilde ved hjælp af separate knapper direkte på enheden. Grundfunktionerne (f.eks. afspilning, pause, skift til næste eller forrige titel) er til rådighed for alle afspilningskilder.

- DAB** DAB-radio. Til afspilning af digitale radiokanaler, der kan nås via antenne. Ved første start udføres en automatisk søgning.
- FM** FM-radio. Til afspilning af analoge radiokanaler, der kan nås via antenne. Ved første start udføres en automatisk søgning.
- Internetradio** Til afspilning af radiokanaler, der kan streames fra internettet.
- PODCAST** Podcast. Til afspilning af podcast-udsendelser, der kan streames fra internettet.
- Bluetooth®** Til afspilning fra parrede enheder (f.eks. smartphone, tablet) og til afspilning på parrede enheder (f.eks. hovedtelefoner, soundbox).
- AUX** Til afspilning fra eksterne enheder, der er tilsluttet via indgangene "AUX 1" eller "AUX 2".
- DIGITAL** Til afspilning fra eksterne enheder, der er tilsluttet via indgangene "Optical", "Coaxial" eller "HDMI".
- Music icon** Til afspilning fra tre kilder:
 - Eksterne enheder, der er tilsluttet via "USB"-indgangene.
 - Medieservere, der befinder sig i samme netværk.
 - Streamingtjenester, der kan streames fra internettet.
 → Se kapitel "6. Appen sonora audio" (side 39).
- CD** Til afspilning af indspilningsmedier i cd-drevet i formaterne lyd-cd og MP3/WMA-cd.

DK

Flere valg af kilder:
Hovedmenu ⇨ Menu

5. Favoritter

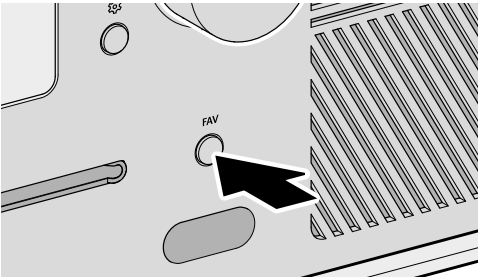

Enheden har en hukommelseskapacitet til 99 favoritter, f.eks. til:

- Radiokanal
- Podcast-udsendelser
- Titler fra streamingtjenester

De første 6 hukommelsespladser på listen over favoritter kan også åbnes via den direkte knap på fjernbetjeningen.

Den ønskede kilde skal afspilles for at gemme en favorit.

FAV ▶ Tryk på knappen, og hold den nede, til listen over favoritter vises.

 ▶ Vælg en hukommelsesplads.

OK ▶ Tryk på betjeningsknappen.

Åbning af en favorit:

FAV ▶ Tryk kortvarigt på knappen. Listen over favoritter vises.

 ▶ Vælg favoritter.

OK ▶ Tryk på betjeningsknappen.

6. Appen sonora audio

 Appen sonora audio kan bruges til styring af enheden via smartphone eller tablet.

Apple App Store (iOS)



Google Play Store (Android)



Musiktjenester

Brugen af appen giver flere funktioner og betjeningsmuligheder. Når smartphonen eller tabletten forbindes med enheden på samme WLAN-netværk, kan der opnås bedre lyd end ved forbindelse via Bluetooth®.



Amazon Music HD®, Deezer®, Napster® og Qobuz® kan kun styres via appen sonora audio.



Spotify Connect® og TIDAL Connect® gør det muligt at styre enheden direkte via streamingudbyderens app.



Eksterne enheder, der er tilsluttet via "USB"-indgangene, eller medieservere, der befinder sig i samme netværk, kan styres via appen sonora audio.

7. Betjeningsvejledning og support



Alle oplysninger vedrørende brug af enheden står i betjeningsvejledningen. <https://manuals.sonoro.com>



Har du brug for hjælp?
▶ Så gå ind på vores support-websted for at få flere oplysninger. <https://support.sonoro.com>

DK

Quick Start Guide 01.2024 / V5
MEISTERSTÜCK (Gen. 2)
SO-620